

GSA product catalog

furniture for technology workspaces



Serving the U.S. government with quality products & services for over 35 years

Eaton has been providing world-class solutions for technology-intensive environments since 1934 and we've been a GSA Contract vendor for over 30 years.

Support from concept to installation and beyond

Our project management team, which includes a dedicated design team, customer care team and technical sales experts, will see your project through from concept to installation and beyond.

Design and technical expertise

Our design and technical experts will visit you on-site. We do the measuring, inventory your equipment, and determine the requirements necessary to meet your unique needs.

Next, our creative designers develop customized drawings to bring your workspace concepts to life, so you can visualize just how things will look once they are installed in your space.

Certified installation support

Once the design is approved and the products are manufactured to your specifications, our project management team will schedule an installation plan that helps minimize disruption for your staff. Our certified installers arrive to take care of unpacking, assembling and arranging all of the equipment as well as coordinating technical integration with your on-site information systems teams.

Service and support

For continued support, we provide services and extended warranties on all of our products. Simply contact your local Eaton sales representative for assistance.



Complimentary 3-D CAD drawings and color renderings of your proposed solution.

GSA contract numbers

Contract No: GS-03F-030DA

Schedule 71:

Office Furniture

SIN 711 2:

Workstations, Computer Furniture & Accessories

SIN 711 3:

Filing & Storage Cabinets

SIN 711 94:

Design & Layout Services

SIN 71310:

Industrial & Institutional Furniture

SIN 711 95:

Installation Services

**Navy FISC Spiral III Blanket Purchase Agreement
BPA No. N00189-17-A-0084**

SIN 711 2:

Workstations, Computer Furniture & Accessories

SIN 711 3:

Filing & Storage Cabinets



Tech Office

- OnGuard** command console..... 4-7
- Profile** advanced console system..... 8-11
- LMS** technical lab furniture 12-13
- TechBench** workbench system 14-17

General Office

- Compass** sit-to-stand modular desking system 18-20
- Compass** modular desking system 21-23
- LINX** modular office furniture 24-27
- Optimedia** storage system..... 28-39
- Filing Companions** storage and filing accessories 40
- TechCart** mobile furnishings..... 41-45



Data Center Solutions

- Paramount** enclosure system 46-47

Options

- Seating** 48-49
- Colors and finishes** 50-52



Eaton reserves the right to make changes to the specifications, materials, equipment, prices, or the availability of products at any time without prior notice. While every effort has been made to assure the accuracy of information contained in this catalog at the time of publication, we cannot accept responsibility for inaccuracies resulting from undetected errors or omissions.

This catalog represents a small sampling of Eaton’s GSA product offering. Contact your local Eaton representative for more information.

Environmental sustainability

The following items hold the GREENGUARD Certification.*

- Compass
- LMS
- Profile
- TechCart
- LINX
- Optimedia
- TechBench
- OnGuard

*The GREENGUARD Certification Program is internationally recognized for evaluating product emissions that meet stringent indoor air quality criteria defined by GREENGUARD Environmental Institute (GEI). Products undergo rigorous, third-party testing to determine their impact on indoor air pollution with requirements for ongoing verification. Certified products are recommended for use by leading sustainable building programs including the U.S. Green Building Council’s (USGBC) Leadership in Energy and Environmental Design (LEED) Rating System.

OnGuard Command Console

OnGuard



OnGuard Command Console

OnGuard

Superior performance, less downtime

Eaton's high performance consoles keep your operations running smoothly — day after day, year after year.

The OnGuard™ command console is ideal for a multitude of technology-intensive environments including: public safety answering points (PSAPs), emergency operation centers (EOCs), network operation centers (NOCs), transportation management centers, process control, security and other monitoring and surveillance environments.



Features & benefits

- Large single-surface lift
- Accommodates four to twelve 27" monitors
- Integrated cable lay-in features to help manage cables quickly and easily
- Expanded color options
- Customizable storage options
- Personal Environment System
- Designed and manufactured in U.S. facilities by tenured craftsmen and engineers
- Durable design withstands the rigors of a 24/7/365 multi-shift environment
- Features all steel construction, heavy-duty lifts and durable finish
- Eaton's portfolio of ePDUs (*Power Distribution Units*), UPSs (*Uninterruptible Power Supply*), surge protectors and other power products ensure that your mission-critical operation runs at peak performance

OnGuard command console

OnGuard command console dimensions

	Length (in)	Height (in)	Depth (in)
Small	120.66"	22"*	60.12"
Medium	133.66"	22"*	60.12"
Large	145.66"	22"*	60.12"

*The worksurface height ranges from 22" (lowest) to 47.60" (highest)



OnGuard Command Console

OnGuard command consoles are designed to handle as few as four monitors and up to as many as twelve 27 inch monitors. The size of the units allow flexibility in monitor layouts as your business and technology changes.

A. TechTrack

Located in the center of the worksurface, the TechTrack is a perfect spot for monitor placement. It houses the air vents for the optional Personal Environment System, and it can accommodate connective accessories such as USB, charging ports or data jacks.

B. TechCurb

Allows for cables to be routed continuously around the perimeter of the workstation. Cables and power are conveniently accessed right at the desktop.

C. Comfort edge

The front of the worksurface has an ergonomic urethane edge for maximum user comfort.

D. Monitor pole track

The monitor pole track (located on the left and right sides of the worksurface), allows for monitor pole mounting based on your design. The patent-pending track facilitates optimal placement, and provides the flexibility to relocate in the future without causing damage to the worksurface.

E. Lift technology

All OnGuard command consoles feature lifts to accommodate the varying heights of operators who share workstations, as well as provide sit-to-stand flexibility for users throughout their shift; promoting a healthier work environment.

F. Steel or laminate base unit panels

OnGuard may be ordered with steel or laminate end and rear panels to complement the design of your work environment.



OnGuard Command Console

OnGuard

OnGuard command console – small

Item	Description	Qty.
Configured	Small OnGuard unit	
AWS553DRM8F	OnGuard console, 4 monitor wide base unit, steel rear panels, steel end panels, left 3 drawer storage, right rack mount storage, center personal environment storage, Freedom color collection	
KONWLC20B	20" Monitor mounting column & base plate kit	3
KONWLK0B	Pitch/pivot column head kit	
KOWNWLK2B	Articulating column arm kit	2



OnGuard command console – medium

Item	Description	Qty
Configured	Medium OnGuard unit	
AWS56CP2D4P	OnGuard console, 4 monitor wide base unit, steel rear panels, laminate end panels, left CPU storage, right 2 drawer storage, center CPU storage, Patriot color collection	
KONWLC30B	30" Monitor mounting column & base plate kit	2
KONWLK2B	Articulating arm kit	6



OnGuard command console – large

Item	Description	Qty
Configured	Large OnGuard unit	
AWL66CPCP4L	OnGuard console, 6 monitor wide base unit, laminate rear panels, laminate end panels, left CPU storage, right CPU storage, center CPU storage, Liberty color collection	
KONWLC20B	20" Monitor mounting column & base plate kit	3
KONWLK2B	Articulating column arm kit	6



Profile Advanced Console System



Profile

Created specifically for high-density Flat Panel Display (FPD) monitoring applications, the Profile™ Console System features a versatile design that makes it ideal for a multitude of technology-intensive environments, including dispatch centers, network operation centers, medical imaging reading rooms, nurses stations and security stations.

Features & benefits

- Offers advanced technology access and integrated cable management solutions
- Ultra-durable steel frame system designed to withstand the rigors of 7x24 environments
- Sophisticated, ergonomic console solutions that manage the convergence of today's technology and the human interface with which it integrates
- Perfect for applications where sit-to-stand accommodation is desired
- Single and dual electronic height-adjustable solutions, as well as manual height-adjustable keyboard platforms

Profile Advanced Console System



Profile

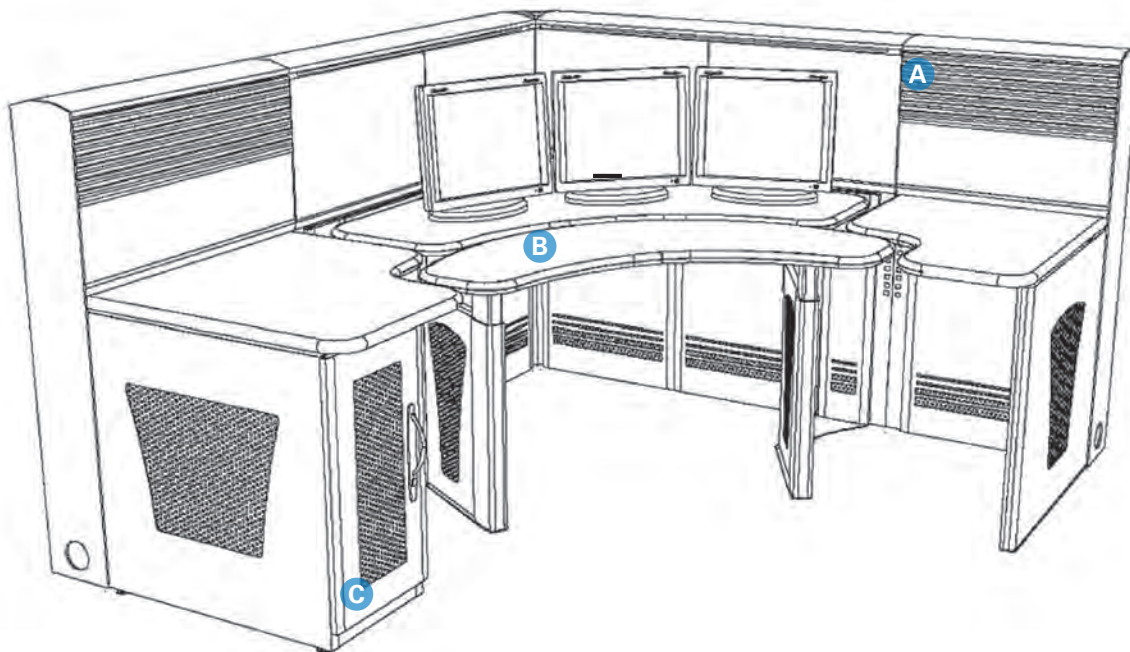

- A FPD integration** – aluminum extruded slatwall inserts allow mounting of FPDs and various filing accessories. The slatwall insert includes an easily removable panel to access interior cabling.
- B Electronic lifting worksurface** allows for an ergonomically correct operation. Available in dual or single lift or single lift with manual height-adjustable keyboard platform. Perfect for applications where sit-to-stand accommodation is desired.
- C High density technology storage** featuring ventilation perforations which help increase convection airflow. Front and rear access offers ease of service.

Profile Advanced Console System

72" Linear station

Item	Description
Configured	72"W x 30"D Linear control/communications station with 16"H flat panel mounting wall
PC7229S1	72"W, Steel core, double sided
PBW7230D	72"W x 30"D Bullnose worksurface with rounded corners on left hand and right hand sides
PCPR1428	4"W x 28"D, CPU docker, right swing door with roll-out shelf
PUPRFLH1	30" Full depth left upright
PCSK1000	10" Removable steel skin
PCSK2200	22" Removable steel skin
PCSK2400	24" Removable steel skin
PDW7216S	72"W x 16"H Modular slatwall
PDWT72S1	72" Top trim
PVET16T1C	Vertical end trim with cable port (qty. 2)
FPDARMWL9	Adjustable FPD mount (qty. 2)

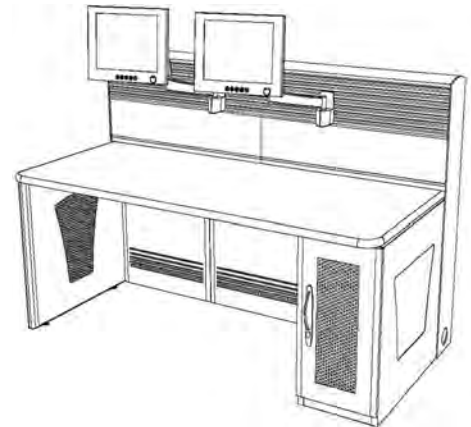

78" Dual lift corner station

Item	Description
Configured	Ergonomic, dual lift, 78"W x 54"D corner control/communications station
PC2429S1	24"W, Single-sided core
PC3029S1	30"W, Single-sided core
PC4829S1	48"W, Single-sided core (qty. 2)
PEC48482	48"W, 48"D Corner with dual electronic lift worksurfaces
PCPR1428	Single CPU docker with left swing door
PCSK1400	14" Removable skin
PCSK2000	20" Removable skin
PCW2430R	24"W x 30"D Curvilinear worksurface
PCW3030L	30"W x 30"D Curvilinear worksurface
PDW2416S	24"W x 16"D Modular slatwall
PDW3016S	30"W x 16"D Modular slatwall
PMW4816S	48"W x 16"D Modular wall (qty. 2)
PDWT48S1	48" Top trim (qty. 2)
PDWT24S1	24" Top trim
PDWT30S1	30" Top trim
PET116P1	90"D Corner wedge
PUPRFLH1	30" Full depth right upright
PVET16T1C	Tier 1 vertical end trim (qty. 2)
PWFP2416	24" Fabric insert (qty. 4)

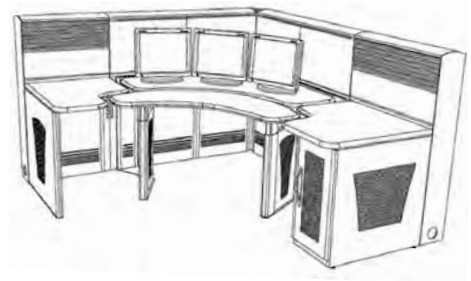

Profile Advanced Console System

102" Dual lift linear station

Item	Description
Configured	Ergonomic, dual lift, 102"W x 30"D linear control/communications station
PBW3030D	30"W x 30"D Bullnose worksurface
PC3029S1	30"W, Single-sided core
PC7229S1	72"W, Single-sided core
PCPR1428	Single CPU docker with right swing door
PCSK1400	14" Removable skin
PDWT30S1	30" Top trim
PDWT72S1	72" Top trim
PDW3016S	30"W x 16"H Modular slatwall
PEWS72303	72"W Linear dual lift
PMW7216S	72"W x 16"H Modular slatwall
PVET16T1C	Tier 1 vertical end trim (qty. 2)
PWFP3616	24" Fabric insert (qty. 2)
PUPRSLH1	30"D Cantilever top support left

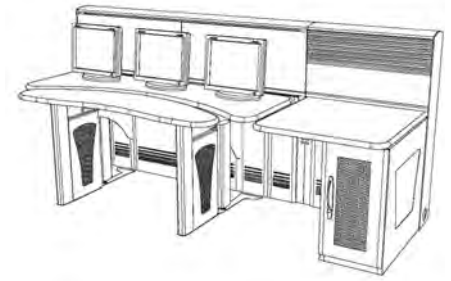

Profile

LMS Technical Lab Furniture

LMS



LMS Technical Lab Furniture

Eaton’s modular LMS™ furniture provides the highly efficient design and configuration capabilities required in today’s lab environments. Specializing in the integration of people, technology, workspace and workflow, Eaton’s approach to building effective and efficient laboratories encompasses four basic principles:

- Ergonomic workspace
- Technology integration
- Modular configuration
- Vertical space utilization



Computer/graphics stations

Configured	LMS 1 – 36" wide
7L07	72" Upright, 31"D (qty.2)
7LG1	72" X 36" Full frame
MG19	36" Mobile base, 31"D
LG32	36" Worksurface, 27"D
LG25	36" Tower shelf/11.9"
LG26	36" Tower add-on shelf
KBTRY18	Keyboard platform with sliding mouse tray
LG33	36" Horizontal cable management kit (qty. 2)

Configured	LMS 2 – 48" wide
7L07	72" Upright, 31"D (qty. 2)
7LE1	72" X 48" Full frame
ME19	48" Mobile base, 31"D
LE32	48" Worksurface, 27"D
LE25	48" Tower shelf/11.9"
LE26	48" Tower add-on shelf
KBTRY18	Keyboard platform with sliding mouse tray (qty. 2)
LE33	48" Horizontal cable management kit (qty. 2)

Configured	LMS 3 – 72" wide
7L07	72" Upright, 31"D (qty. 2)
7LF1	72" X 72" full frame, (3) 24" modules
LF19	72" Standard caster base
LF32	72" Hook-on worksurface
LF25	72" Tower shelf/11.9"
LF26	72" Tower add-on shelf
LF33	72" Horizontal cable management kit (qty. 2)
KBTRY18	Keyboard platform with sliding mouse tray (qty. 3)

Configured	LMS 4 – 84" wide
8LH1	84"W x 72"H Modular full frame
8L27	84"H Uprights (qty. 2)
LF32	72"W x 36"H Worksurface with cantilevers
MG07	48"W x 18"H Hook-on laminate shelves (qty. 4)

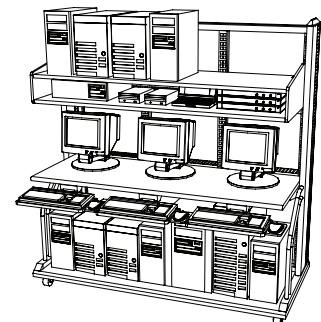
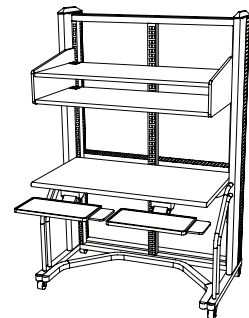
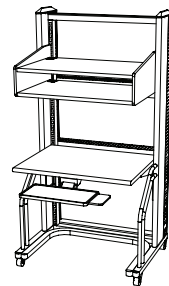

LMS

TechBench Workbench System



TechBench

TechBench Workbench System

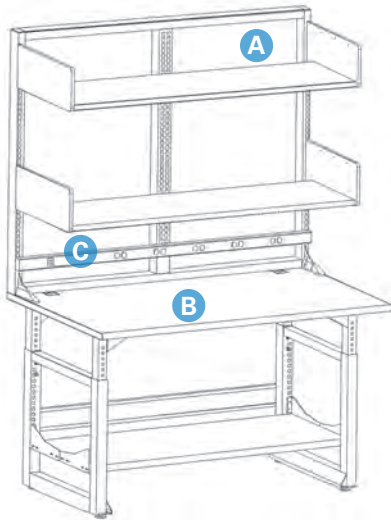

A Strong, durable, modular steel TechOrganizer allows for a myriad of desktop and overhead storage accessories and options. Helps to keep work surfaces clear and contributes to proper 'lean' lab management principles.

B Worksurfaces are available in high-pressure laminate, phenolic resin and maple hardwood.

C Integrated modular power and data distribution solutions are available.

Features & benefits

- Strength and durability required in today's instrumentation chemistry applications
- Optional components for space management and storage for analytical instrumentation and supplies
- Flexible solutions for flat panel displays, computers, keyboards, power, and data
- Height configurable from desk to workbench height
- Available in 24" to 96" widths and 30" and 36" worksurface depths
- Multiple worksurface materials are available

Linear TechBench (laminate worksurface)

Item	Description
TBLW7236A	72"W x 36"D TechBench with laminate worksurface
TBLW6036A	60"W x 36"D TechBench with laminate worksurface
TBLW4836A	48"W x 36"D TechBench with laminate worksurface
TBLW3636A	36"W x 36"D TechBench with laminate worksurface

Linear TechBench (maple worksurface)

Item	Description
TBMW7236A	72"W x 36"D TechBench with solid maple worksurface
TBMW6036A	60"W x 36"D TechBench with solid maple worksurface
TBMW4836A	48"W x 36"D TechBench with solid maple worksurface
TBMW3636A	36"W x 36"D TechBench with solid maple worksurface

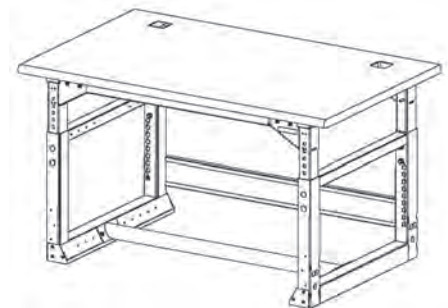

TechBench Workbench System

Configured linear TechBench - 48" wide

Item	Description
Configured	48"W x 36"D TechBench with 48" TechOrganizer and shelving
TBLW4836A	48"W x 36"D TechBench with laminate worksurface
TBAFS4822	Adjustable full shelf
TF48481	48"W x 48"H TechOrganizer
LE21	48" Electronic shelf (qty. 2)



Configured linear TechBench - 72" wide

Item	Description
Configured	72" Wide configured TechBench
TBLW7230A	72"W X 30"D Linear TechBench with laminate top
TBAPS7212	72" Partial shelf
TF48721	48"H Linear TechOrganizer, 72"W
BLS7218	72" Laminate shelf, 18"D
TWB1924	19"H White board, 24"W
MB40	24" Small bin rail (qty. 3)
TPB3624	36"H Peg board, 24"W
C98009	3" Akro-bins (case of 24), yellow
C830MM	(6"/12") Suspended pedestal
TBFACP1530	Fixed accessory plate

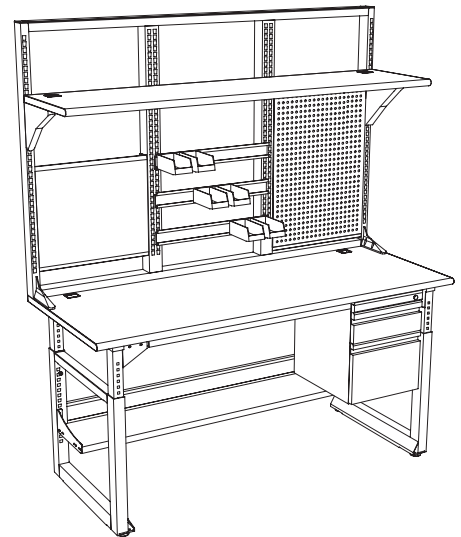

Configured linear TechBench - 72" wide with storage cabinet

Item	Description
Configured	72" Wide configured TechBench
TBLW7230A	72"W X 30"D Linear TechBench with laminate top
TF48721	48"H Linear TechOrganizer, 72"W (24")
BLS7218	72" Plus laminate shelf, 18"D
TWB1924	19"H White board, 24"W
MB40	24" Small bin rail (qty. 3)
TPB3624	36"H Peg board, 24"W
C98009	3" Akro-bins (case of 24), yellow
UM72MM	Optimedia caster base, 36"W
1M41	28" Under bench optimedia cabinet preconfigured with (4) 6" drawers

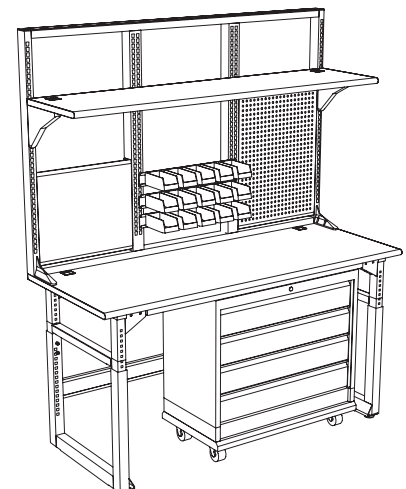

TechBench Workbench System

Configured linear TechBench - 48" wide

Item	Description
Configured	48" Wide configured TechBench
TBLW4830A	48"W X 30"D Linear TechBench with laminate top
TF48481	48"H Linear TechOrganizer, 48"W
TPB3624	36"H Peg board, 24"W
TBB3224	32"H Bin board, 24"W
BLS4818	48" Plus laminate shelf, 18"D
C845	Box/box/file mobile pedestal
C98009	3" Akro-bins (case of 24), yellow

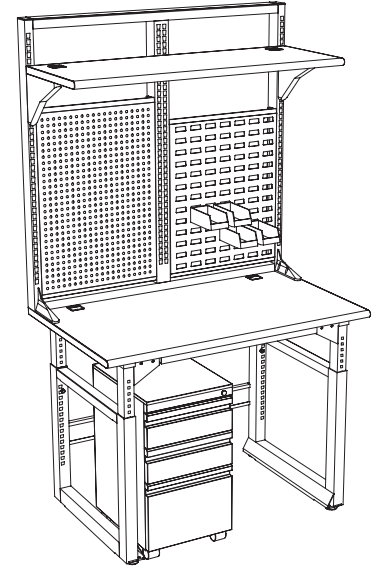

Linear TechBench accessories

Item	Description
TBHDC0558	Heavy-duty caster kit (includes set of 4 casters)
TBFT4800A	Foot rest tube



TechBench

A full line of analytical lab furniture is available.
Contact your local account representative for pricing.

Compass Sit-to-Stand Modular Desking System



Compass
sit-to-stand

Compass Sit-to-Stand Modular Desking System

Eaton’s Compass™ modular desking system now includes a new sit-to-stand option. This height-adjustable workstation allows the freedom to sit or stand while working. The Compass sit-to-stand offers all the features of the classic Compass line, including a freestanding, steel-based design that exceeds industry requirements for strength and durability.

Its modularity permits unlimited configuration possibilities to reflect the work styles of your people in open or private office settings. It is completely scalable and reconfigurable. And, contemporary worksurface designs with multiple options for finishes and fabrics ensure a high-end aesthetic appeal.



Features & benefits

- Flexible, durable and adjustable
- Customizable and scalable
- Technology integration
- Ergonomics and comfort with Compass sit-to-stand options
- Contemporary designs with multiple finish and fabric choices
- Modular design allows unlimited reconfigurability
- Slim profile maximizes valuable office space
- Ideal for both private and open office configurations

Free standing linear

Item	Description
Configured	Linear free standing workstation
CWFSS4824	Linear free standing 48 x 24
CWFSS4830	Linear free standing 48 x 30
CWFSS6024	Linear free standing 60 x 24
CWFSS6030	Linear free standing 60 x 30
CWFSS7224	Linear free standing 72 x 24
CWFSS7230	Linear free standing 72 x 30

Integrated linear

Item	Description
Configured	Linear workstation
CWSS4824	Linear integrated – 48 x 24
CWSS4830	Linear integrated – 48 x 30
CWSS6024	Linear integrated – 60 x 24
CWSS6030	Linear integrated – 60 x 30
CWSS7224	Linear integrated – 72 x 24
CWSS7230	Linear integrated – 72 x 30

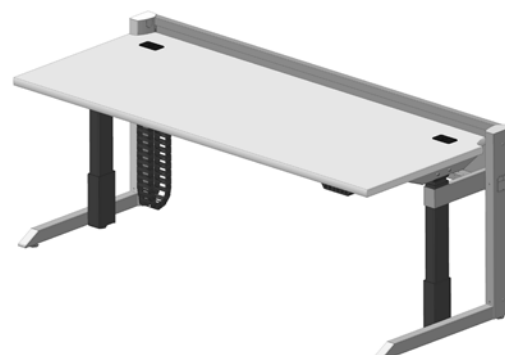

Compass
sit-to-stand

Compass Sit-to-Stand Modular Desking System

Free standing corner

Item	Description
Configured	Corner workstation
CWFSS48481	Corner free standing – 48 x 48 – 24" deep
CWFSS48482	Corner free standing – 48 x 48 – 30" deep
CWFSS4848L	Corner free standing – 48 x 48 – 30L/24R
CWFSS4848R	Corner free standing – 48 x 48 – 24L/30R
CWFSS48601	Corner free standing – 48 x 60 – 24/24
CWFSS48602	Corner free standing – 48 x 60 – 30/30
CWFSS4860L	Corner free standing – 48 x 60 – 30L/24R
CWFSS4860R	Corner free standing – 48 x 60 – 24L/30R
CWFSS48721	Corner free standing – 48 x 72 – 24/24
CWFSS48722	Corner free standing – 48 x 72 – 30/30
CWFSS4872L	Corner free standing – 48 x 72 – 30L/24R
CWFSS4872R	Corner free standing – 48 x 72 – 24L/30R
CWFSS60481	Corner free standing – 60 x 48 – 24/24
CWFSS60482	Corner free standing – 60 x 48 – 30/30
CWFSS6048L	Corner free standing – 60 x 48 – 30L/24R
CWFSS6048R	Corner free standing – 60 x 48 – 24L/30R
CWFSS72481	Corner free standing – 72 x 48 – 24/24
CWFSS72482	Corner free standing – 72 x 48 – 30/30
CWFSS7248L	Corner free standing – 72 x 48 – 30L/24R
CWFSS7248R	Corner free standing – 72 x 48 – 24L/30R
CWFSS72722	Corner free standing – 72 x 72 – 30/30



Integrated corner

Item	Description
Configured	Corner workstation
CWSS48481	Corner integrated – 48 x 48 – 24" deep
CWSS48482	Corner integrated – 48 x 48 – 30" deep
CWSS4848L	Corner integrated – 48 x 48 – 30L/24R
CWSS4848R	Corner integrated – 48 x 48 – 24L/30R
CWSS48601	Corner integrated – 48 x 60 – 24/24
CWSS48602	Corner integrated – 48 x 60 – 30/30
CWSS4860L	Corner integrated – 48 x 60 – 30L/24R
CWSS4860R	Corner integrated – 48 x 60 – 24L/30R
CWSS48721	Corner integrated – 48 x 72 – 24/24
CWSS48722	Corner integrated – 48 x 72 – 30/30
CWSS4872L	Corner integrated – 48 x 72 – 30L/24R
CWSS4872R	Corner integrated – 48 x 72 – 24L/30R
CWSS60481	Corner integrated – 60 x 48 – 24/24
CWSS60482	Corner integrated – 60 x 48 – 30/30
CWSS6048L	Corner integrated – 60 x 48 – 30L/24R
CWSS6048R	Corner integrated – 60 x 48 – 24L/30R
CWSS72481	Corner integrated – 72 x 48 – 24/24
CWSS72482	Corner integrated – 72 x 48 – 30/30
CWSS7248L	Corner integrated – 72 x 48 – 30L/24R
CWSS7248R	Corner integrated – 72 x 48 – 24L/30R

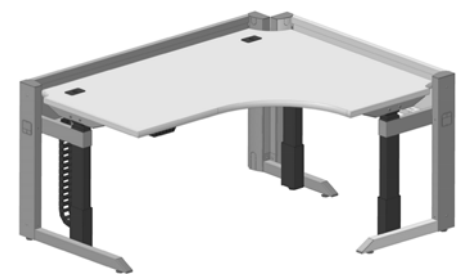

Compass sit-to-stand

Compass Modular Desking System

The perfect combination for your ideal work environment. It all starts with Compass' construction – a freestanding, steel-based design that exceeds industry requirements for strength and durability. Its modularity permits unlimited configuration possibilities to reflect the work styles of your people in open or private office settings. It is completely scalable and reconfigurable. And, contemporary worksurface designs with multiple options for finishes and fabrics ensure a high-end aesthetic appeal.



Features & benefits

- Contemporary designs with multiple finish and fabric choices
- Modular design allows unlimited reconfigurability
- Slim profile maximizes valuable office space
- Ideal for both private and open office configurations

Compass L-shaped corner workstation 6' x 8'

Item	Description
Configured	L-shaped corner workstation
CDS48C	Locking Compass door 48"W corner
CDS48L	Locking Compass door 48"W linear
CLC29	Corner upright 29"H
CLCS48C	Locking compartment 48" corner
CLCS48L	Locking compartment 48" linear
CLF2429L	Full depth leg 24"D x 29"H left
CLF3029R	Full depth leg 30"D x 29"H right
CLLT3029	Linked transition upright 30"D x 29"H
CM48C	48"W Modesty panel corner
CM48L	48"W Modesty panel linear
CM72C	72"W Modesty panel corner
COFJ4820C	Fabric panel 48"W x 20"H J hook corner
COFJ4820L	Fabric panel 48"W x 20"H J hook linear
COU36	Organizer upright 36"H (qty. 2)
CWCT7248R	72" x 48" Corner WS 24"D transition
CWL4830	48"W x 30"D WS linear

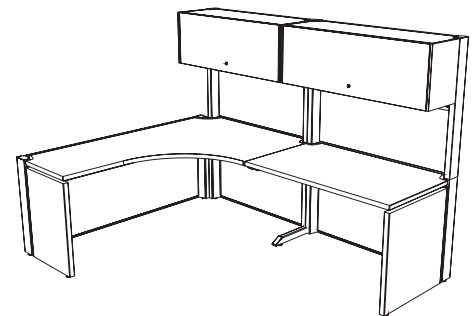

Compass

Compass Modular Desking System

Compass Corner workstation 7' x 7'

Item	Description
Configured	Corner workstation
CDF36L	Locking Compass door fabric panel 36"W linear (qty. 2)
CLC65	Corner upright 65"H
CLC36L	Locking Compass 36"W linear (qty. 2)
CLS2465L	Standard upright 24"D x 65"H left
CLS2465R	Standard upright 24"D x 65"H right
CM36L	Modesty panel 36"W linear (qty. 2)
CM48C	Modesty panel 48"W corner (qty. 2)
COFJ3620L	36"W x 20"H Fabric panel J hook corner (qty. 2)
COFJ4816C	48"W x 16"H Fabric panel J hook corner (qty. 2)
COFJ4820C	48"W x 20"H Fabric panel J hook corner (qty. 2)
CSL4848	48" x 48" Corner shelf
CWC48481	48" x 48" Corner 24"D WS
CWL3624	36"W 24"D WS linear (qty. 2)
CLT2465L	Transitional upright 24"D x 65"H left (qty. 2)
CLS2465R	Transitional upright 24"D x 65"H right (qty. 2)

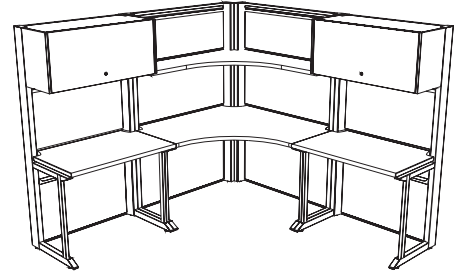

Compass linear workstation 6'

Item	Description
Configured	Linear workstation
CDS60L	60" Linear Compass door steel
CLCS60L	60"W Linear locking compartment
CLS3029L	Standard leg 30"D x 29"W left
CLS3029R	Standard leg 30"D x 29"W right
COFJ6020L	Fabric panel 50"W x 20"H linear
COU36	Organizer upright, 36"H
CWL6030	60"W x 30"D linear WS

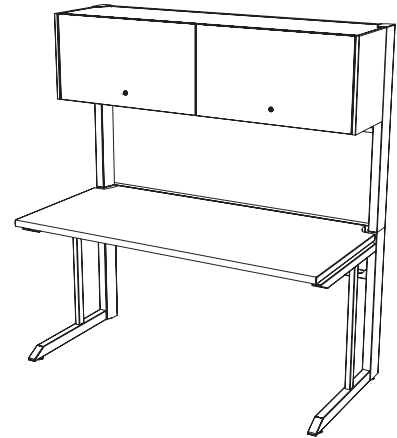

Compass Modular Desking System

Compass u-shaped conference end workstation 8' x 8' right

Item	Description
Configured	U-shaped workstation right
CDC48L	Locking Compass door 48"W linear
CLC29	Corner upright 29"H
CLCS48L	Locking compartment 48" linear
CLF1829R	Full depth leg 18"D x 29"H right
CLF2429L	Full depth upright 24"D x 29"H left
CLLT2429	Linked transition upright 24"D x 29"H (qty. 2)
COF4816C	Fabric panel 48"W x 16"H corner
COF4820C	Fabric panel 48"W x 20"H corner
COF4820L	Fabric panel 48"W x 20"H linear
COFJ3616L	Fabric panel 36"W x 16"H linear J hook
COFJ4816C	Fabric panel 48"W x 16"H linear J hook
COU16	Organizer upright 16"H (qty. 2)
COU36	Organizer upright 36"H (qty. 2)
CSL48C	48"W Linear shelf corner WS
CWC48481	48" x 48" corner WS 24"D
CWJ48721R	Jetty WS 48" x 72", 24"D right
CWL4824	48"W x 24"D WS linear

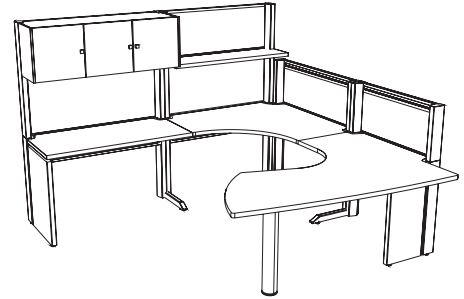

Compass u-shaped conference end workstation 8' x 8' left

Item	Description
Configured	U-Shaped workstation left
CDC48L	Locking Compass door 48"W linear
CLC29	Corner upright 29"H
CLCS48L	Locking compartment 48" linear
CLF1829L	Full depth leg 18"D x 29"H left
CLF2429R	Full depth upright 24"D x 29"H right
CLLT2429	Linked transition upright 24"D x 29"H (qty. 2)
COF4816C	Fabric panel 48"W x 16"H corner
COF4820C	Fabric panel 48"W x 20"H corner
COF4820L	Fabric panel 48"W x 20"H Linear
COFJ3616L	Fabric panel 36"W x 16"H linear J hook
COFJ4816C	Fabric panel 48"W x 16"H Linear J hook
COU16	Organizer upright 16"H (qty. 2)
COU36	Organizer upright 36"H (qty. 2)
CSL48C	48"W Linear shelf corner WS
CWC48481	48" x 48" Corner WS 24"D
CWJ48721L	Jetty WS 48" x 72", 24"D left
CWL4824	48"W x 24"D WS linear

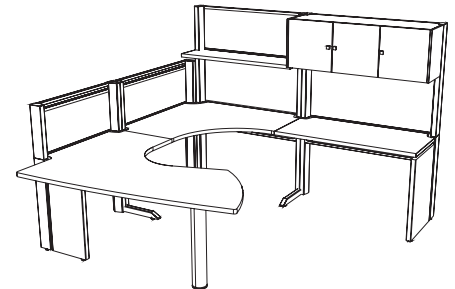

Compass

LINX Modular Office Furniture



LINX Modular Office Furniture

LINX™ modular furniture is a freestanding technical desking platform, that gives you and your facility planners the ultimate flexibility in creating a space efficient office layout.

Features & benefits

- Free-standing technical desking platform with detachable storage walls provides the ultimate in flexibility
- Reconfigurable system adapts to meet your needs
- Provides a universal platform for multiple modular technology applications
- Distinct monitor technology integration
- Integrated vertical and horizontal cable management
- Perfect for the private office, open team workstations, conferencing and training



LINX Modular Office Furniture



LINX 6' linear workstation

Item	Description
Configured	6' Linear workstation
WT7230F29	72" x 30" LINX top
WLSU2930	29"H x 30"D Left standard upright
WRSU2930	29"H x 30"D Right standard upright
C845	Box/box/file mobile pedestal
C846	File/file mobile pedestal
KBTRY18	Adjustable keyboard tray



Shown with optional CPU caddy.

LINX linear workstation with separate conference desk

Item	Description
Configured	U-shaped workstation
WT7224F29	72" x 24" LINX top
WLFU2924	29"H x 24"D Left full upright
WRFU2924	29"H x 24"D Right full upright
WTBW72F29	72" x 36" Bow top
WLFU2930	29"H x 30"D Left full upright
WRFU2930	29"H x 30"D Right full upright
W417205	72" Organizer 41"H with fabric doors
C847	LINX utility drawer
KBTRY18	Adjustable keyboard tray
W168	48" Task light for shelving

LINX corner workstation

Item	Description
Configured	Corner workstation
WT3624F29	36" x 24" LINX top
WLFU2924	29"H x 24"D Left full upright
WRTU2919	29"H x 19"D Right transitional upright
WT7230F29	72" x 30" LINX top
WLFU2930	29"H x 30"D Left full upright
WRFU2930	29"H x 30"D Right full upright
W367205	72" Organizer 36"H with fabric
W168	48" Task light for shelving
WD72	72" Overhead laminate shelf
C846	File/file mobile pedestal
C857	Keyboard bridge
W150	Right slanted sorter file (qty. 2)



LINX Modular Office Furniture



Shown with optional Optimedia cabinet.

LINX corner workstation with curved jetty

Item	Description
Configured	Corner workstation with curved jetty
WFC722F29	48" Right x 72" left freestanding curved corner top
WLFU2924	29"H x 24"D Left full upright
WRTU2919	29"H x 19"D Right transitional upright
WJ2R48F29	Right jetty top (24" side)
WLTU2919	29"H x 19"D Transitional upright
WRFU2924	29"H x 24"D Right full upright
W507205	72" Organizer, 50"H with fabric doors
W168	48" Task light for shelving
C845	Box/box/file mobile pedestal
KONWL11D	FPD arm

LINX team workstation



Item	Description
Configured	Team workstation
WFC723F29	48" Left x 72" right freestanding curved corner
WLSU2930	29"H x 30"D Left standard upright
WRTU2919	29"H x 19"D Right transitional upright
WBP721F29	72" x 30" Bolt-on peninsula top
WFC724F29	48" Right x 72" left freestanding curved corner
WLTU2919	29"H x 19"D Left transitional upright
WRSU2930	29"H x 30"D Right standard upright
W348722	48" x 72" Corner organizer with four fabric panels (36"H) (qty. 2)
WS4872L	48" Left x 72" right curved corner shelf left
WS4872R	48" Right x 72" left curved corner shelf right
W363005	30" Organizer 36"H with fabric
W160	24" Task light for 30" shelving (qty. 3)



LINX bullet conference tables

Item	Description	Dimensions
W990	48" Bullet conference	29"H x 48"W x 36"D
W992	60" Bullet conference	29"H x 60"W x 36"D
W993	72" Bullet conference	29"H x 72"W x 36"D
W994	84" Bullet conference	29"H x 84"W x 36"D
W995	96" Bullet conference	29"H x 96"W x 36"D

Optimedia Storage System

Optimedia



Optimedia Storage System

Optimedia

Optimedia specifications

The Optimedia™ product line includes five core cabinet types with many interchangeable storage components that are easy to remove and reconfigure.

- Sidewinder™ tambour cabinets feature side opening tambour doors
- Classic tambour cabinets have front-to-back receding tambour doors
- Partial tambour cabinets offer a combination closure, with a classic tambour door at the top, and modular steel drawers at the bottom
- Extra-deep cabinets with high-capacity storage (24" deep footprint)

Cabinet construction and specifications

- Heavy gauge steel, fully welded and reinforced
- Top, sides, back panels and uprights are manufactured of 20-gauge cold-rolled steel (CRS)
- Bottom is 18-gauge CRS
- All side seams are hidden for a smooth, finished appearance
- Shell includes four (4) welded internal uprights at corners of cabinet body, slotted at 1/4" intervals for four post support of storage components
- Shell equipped with advanced safety interlocks which help prevent two roll-outs from being pulled out simultaneously* †
- Includes removable core lock for security.
- Options for individually keyed cabinets available.

*Cabinets with extra-deep shells do not include this feature

† Applies to configurations using multiple roll-out components

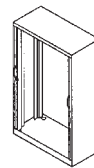

A - Sidewinder tambour

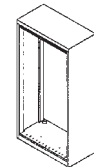

B - Classic tambour

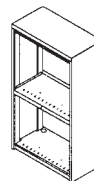

C - Partial tambour

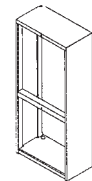

D - Door/drawer

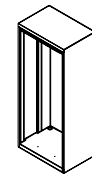

E - Extra-deep

Optimedia Storage System Modular Drawer Cabinets

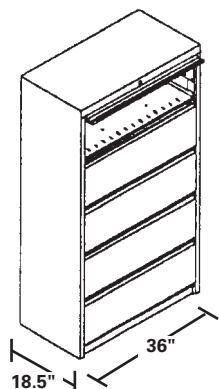

A Removable core lock is keyed and controls ganglock to secure all doors and drawers.

B Modular drawer. Typically used for storage or for drop filing.

Features & benefits

- Feature smooth-faced steel modular drawers
- Drawers include full pull handles
- Base of cabinet is recessed in front to match handle pulls on drawers.

Cabinets with modular drawers for hanging files

Item	Components	Dimensions			Shipping Weight
		H	W	D	
1M23	12" Modular drawers (includes 2)	28"	36"	18.5"	150.25 lbs.
1M17	6" Drawers (includes 2) 12" Modular drawer	28"	36"	18.5"	169.5 lbs.
2M72	12" Modular drawers (includes 2)	29.24"	36"	18.5"	168 lbs.
4M72	12" Modular drawers (includes 3)	41.24"	36"	18.5"	173 lbs.
3M72	12" Modular drawers (includes 4)	53.24"	36"	18.5"	201 lbs.
5M72	6" Drawer 12" Modular drawers (includes 4)	59.24"	36"	18.5"	247 lbs.

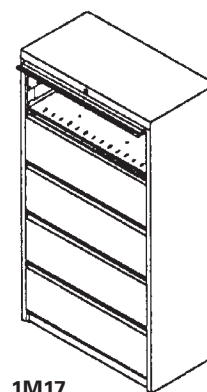

1M17

Accessories

UM77	Back panel	5 lbs.
-------------	------------	--------

Cabinets with 6" modular drawers

Item	Components	Dimensions			Shipping Weight
		H	W	D	
4M32	6" Drawers (includes 6)	41.24"	36"	18.5"	183 lbs.
6M32	6" Drawers (includes 10)	65.24"	36"	18.5"	279 lbs.

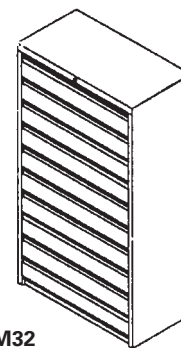

6M32

Optimedia Storage System Sidewinder Tambour Cabinet

Optimedia

Features & benefits

- Vertical PVC tambour doors that fully recede into the sides of the cabinet
- Doors glide smoothly and independently on internal tracks
- Two center handles are finished in black chrome

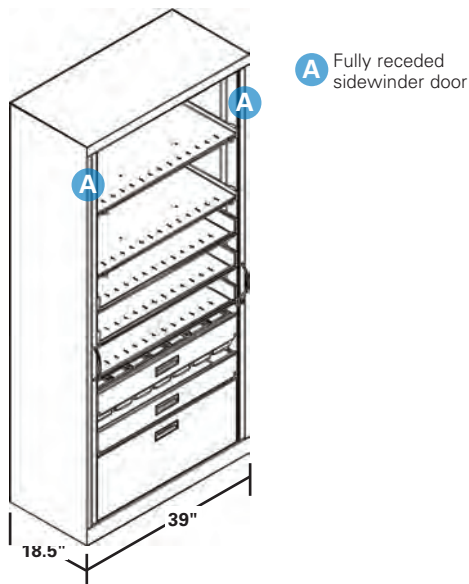

Cabinets for binders and large books

Item	Levels	Media Height	Dimensions			Shipping Weight	Filing In. Per Level
			H	W	D		
5Y65	4	12"	59.24"	39"	18.5"	210 lbs.	33.56"
6Y56	4	13.5"	65.24"	39"	18.5"	217 lbs.	33.56"
7Y56	5	11.75"	71.24"	39"	18.5"	240 lbs.	33.56"
8Y56	6	11.6"	83.24"	39"	18.5"	271 lbs.	33.56"

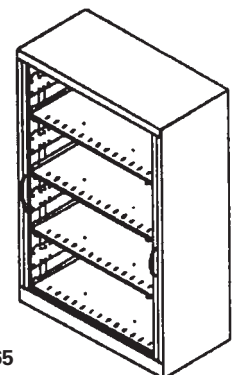

Optimedia Storage System

Sidewinder Tambour - Standard Configurations

Cabinets for hanging files

Item	Levels	Components	Dimensions			Shipping Weight	Filing In. Per Level
			H	W	D		
2Y11	2		29.24"	39"	18.5"	179 lbs.	32.36"
4Y11	3		41.24"	39"	18.5"	159 lbs.	32.36"
6Y11	5		65.24"	39"	18.5"	221.5 lbs.	32.36"
8Y11	7	Fixed shelves at top (includes 2)	83.24"	39"	18.5"	275.5 lbs.	32.36"

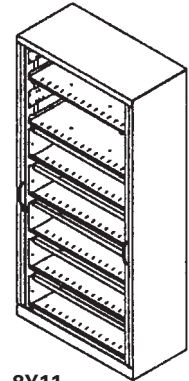

8Y11

Laboratory supplies cabinet

Item	Components	Dimensions			Shipping Weight
		H	W	D	
8Y74	Universal fixed shelves (includes 2) 12" Multipurpose bin drawers (includes 4)	83.24"	39"	18.5"	162 lbs.

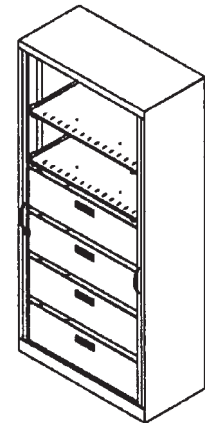

8Y74

Accessories

UM77	Back panel	5 lbs.
UO47FF	Center rails for front-to-back filing	1.5 lbs.

Mixed media cabinet

Item	Components	Dimensions			Shipping Weight
		H	W	D	
8Y34	Universal fixed shelves (includes 2) 4" Roll-out sheves without fronts (includes 3) Hanging frame with (6) hanging diskette files 4" Roll-out shelf with front 15" Multipurpose bin drawer	83.24"	39"	18.5"	302 lbs.

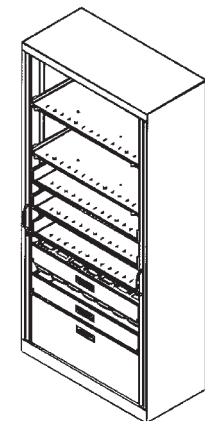

8Y34

Sidewinder Tambour Cabinet - Standard Configurations

Administrative support cabinets

Item	Components	Dimensions			Shipping Weight
		H	W	D	
6Y36	6 Level cabinet to include: Universal fixed shelf for media up to 8.25"H Organizer (unassembled) on fixed shelf 4" Roll-out shelf without front 4" Roll-out shelves with fronts (includes 2) 12" Multipurpose bin drawer	65.24"	39"	18.5"	266 lbs.
8Y36	7 Level cabinet to include: Universal fixed shelves for media up to 12.5" high (includes 2) Organizer (unassembled) on fixed shelf 4" Roll-out shelf without front 4" Roll-out shelves with fronts (includes 2) 12" Multipurpose bin drawer	84.24"	39"	18.5"	175 lbs.

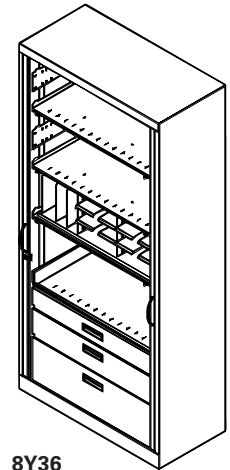

8Y36

Multipurpose supply cabinets

Item	Components	Dimensions			Shipping Weight
		H	W	D	
5Y67	Universal fixed shelves (includes 2) Sets of dividers (includes 2) 4" Roll-outs with fronts (includes 2) 3 Rail divider kit Universal roll-out shelf 12" Multipurpose bin drawer	59.24"	39"	18.5"	262 lbs.
8Y67	Universal fixed shelves (includes 3) Sets of dividers (includes 2) 4" Roll-outs with fronts (includes 2) 3 Rail divider kit Universal roll-out shelves (includes 2) 12" Multipurpose bin drawer	83.24"	39"	18.5"	328 lbs.

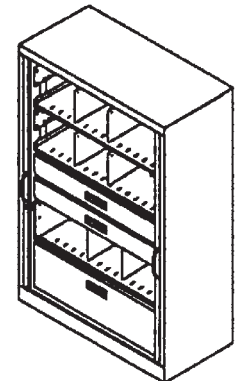

5Y67

Accessories

U048	Optional compartment divider kit	10 lbs.
-------------	----------------------------------	---------

Storage cabinets with fixed shelves

Item	No. of Levels	Dimensions			Shipping Weight
		H	W	D	
8Y55	6	83.24"	39"	18.5"	220 lbs.

Accessories

UM54	Optional back panel kit	6.58"	33.66"	16.52"	7.5 lbs.
-------------	-------------------------	-------	--------	--------	----------

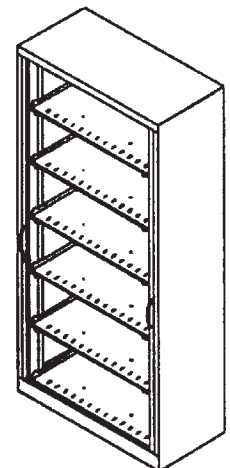

8Y55

Optimedia Storage System

Classic Tambour Cabinet

Features & benefits

- Feature smooth-faced PVC tambour doors which are torsion spring loaded to recede easily into the back of the cabinet
- Classic door locks into base of cabinet (includes lock no. 150000)

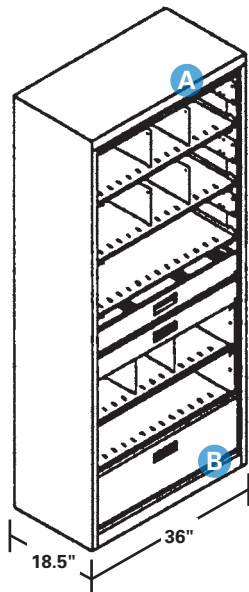

A Classic tambour door fully recedes at top of cabinet.

B Classic door locks into base of cabinet when closed.

Cabinets for binders and large books

Item	Levels	Media Height	Dimensions			Shipping Weight	Filing In. Per Level
			H	W	D		
5M65	4	12.3"	59.24"	36"	18.5"	189 lbs.	33.56"
6M56	4	13.8"	65.24"	36"	18.5"	203 lbs.	33.56"
7M56	5	12"	71.24"	36"	18.5"	226 lbs.	33.56"
8M56	6	11.8"	83.24"	36"	18.5"	249 lbs.	33.56"

Accessories

U045FF	Optional dividers (includes 3)	3.5 lbs.
---------------	--------------------------------	----------

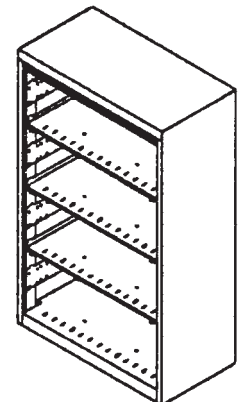

5M65

**Optimedia Storage System
Classic Tambour Cabinet**

Optimedia

Cabinets without doors for binders and large books

Item	Levels	Media Height	Dimensions			Shipping Weight	Filing In. Per Level
			H	W	D		
5M25	4	12.3"	59.24"	36"	18.5"	189 lbs.	33.56"
6M26	4	13.8"	65.24"	36"	18.5"	188 lbs.	33.56"
7M26	5	12"	71.24"	36"	18.5"	210 lbs.	33.56"
8M26	6	11.8"	83.24"	36"	18.5"	240 lbs.	33.56"

Accessories

U045FF	Optional dividers (includes 3)	3.5 lbs.
---------------	--------------------------------	----------

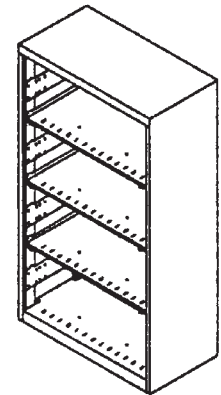

6M26

Cabinets for binders and large books

Item	Levels	Media Height	Dimensions			Shipping Weight	Filing In. Per Level
			H	W	D		
1M52	2	10.25"	28.00"	36"	18.5"	144 lbs.	33.56"
2M52	2	10.8"	29.24"	36"	18.5"	144 lbs.	33.56"
4M52	3	10.8"	41.24"	36"	18.5"	140 lbs.	33.56"
5M66	5	9.6"	59.24"	36"	18.5"	205 lbs.	33.56"
7M57	6	9.8"	71.24"	36"	18.5"	233 lbs.	33.56"
7M59	6 Cabinet with writing shelf	9.5"	71.24"	36"	18.5"	245 lbs.	33.56"
8M59	7 Cabinet with writing shelf	9.7"	83.24"	36"	18.5"	277 lbs.	33.56"

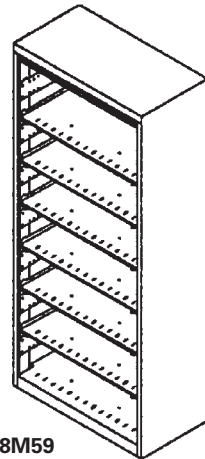

8M59

Accessories

U045FF	Optional dividers (includes 3)	3.5 lbs.
---------------	--------------------------------	----------

LAN support cabinet

Item	Components	Dimensions			Shipping Weight
		H	W	D	
8M34	Universal fixed shelves (includes 2) 4" Roll-outs shelves without fronts (includes 3) Hanging frame with (6) hanging diskette files 4" Roll-out shelf with front 15" Multipurpose bin drawer	83.24"	36"	18.5"	302 lbs.

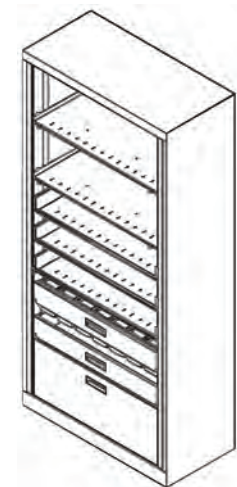

8M34

Optimedia Storage System Classic Tambour Cabinet

Multipurpose supply cabinets

Item	Components	Dimensions			Shipping Weight
		H	W	D	
5M67	Universal fixed shelves (includes 2) Sets of dividers (includes 2) 4" Roll-out shelves with fronts (includes 2) 3-Rail divider kit Universal roll-out shelf 2" Multipurpose bin drawer	59.24"	36"	18.5"	248.5 lbs.
8M67	Universal fixed shelves (includes 3) Sets of dividers (includes 2) 4" Roll-out shelves with fronts (includes 2) 3-Rail divider kit Universal roll-out shelves (includes 2) 12" Multipurpose bin drawer	83.24"	36"	18.5"	315 lbs.

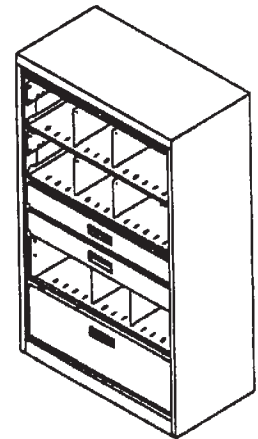

5M67

Accessories

UO48FF	Optional compartment divider kit	83.24"	36"	18.5"	10 lbs.
---------------	----------------------------------	--------	-----	-------	---------

Storage cabinets with fixed shelves

Item	No. of Levels	Dimensions			Shipping Weight
		H	W	D	
5M55	4	59.24"	36"	18.5"	161 lbs.
8M55	6	83.24"	36"	18.5"	276 lbs.

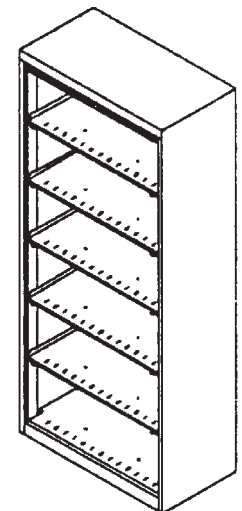

8M55

Accessories

UM54	Optional back panel kit	7.5 lbs.
-------------	-------------------------	----------

Optimedia Storage System Extra-Deep Storage Cabinet

Optimedia

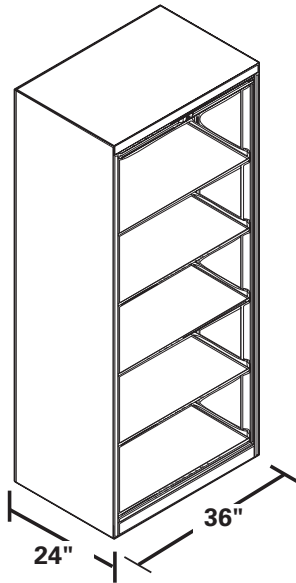

Features & benefits

The Optimedia extra-deep storage cabinet provides storage capacity for large equipment, materials or supplies.

- 24" deep with heavy-duty fixed shelves
- 200 lb. weight capacity
- Classic tambour door is torsion spring loaded to recede easily into the back of the cabinet
- Shelves are installed on .25" slotted uprights, and can be adjusted to different heights

Extra-deep storage cabinet

Item	No. of Levels	Dimensions			Shipping Weight
		H	W	D	
8W55	5-Level extra-deep storage cabinet	83.24"	36"	24"	254 lbs.
8W56	6-Level extra-deep storage cabinet	83.24"	36"	24"	270 lbs.
UW02FF	Extra-deep, heavy duty fixed shelf	6"	34"	21"	16.5 lbs.

- Each heavy-duty fixed shelf has a 200 lbs. weight-load capacity.

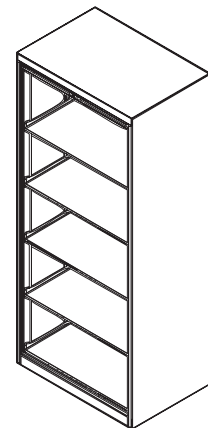

8W56

Optimedia Storage System Components and Accessories

Divided forms shelf

Item	Components	Dimensions			Shipping Weight	Space Req.
		H	W	D		
UM22	Divided forms shelf	9.75"	33.56"	11.5"	28 lbs.	10"

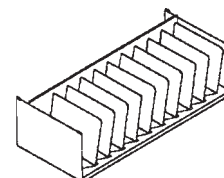

UM22

Stackable shelf

Item	Components	Dimensions			Shipping Weight	Space Req.
		H	W	D		
UM32	Stackable shelf with 2 dividers	4.18"	33.58"	16.5"	10 lbs.	4.25"
UM37	Extra dividers (includes 2)				1 lbs.	
UM38	Brackets for UM32 (includes 2) (limit 5 shelves/pair of brackets)				1.54 lbs.	

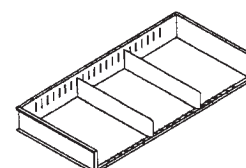

UM32

File sorter

Item	Components	Dimensions			Shipping Weight	Space Req.
		H	W	D		
UM64	File sorter	11.31"	33"	15"	40 lbs.	12.5"
UM65	Additional 10" wide shelf				2.25 lbs.	
UM66	Additional 11" wide shelf				2.5 lbs.	

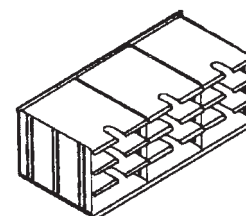

UM64

- To be inserted on a fixed shelf (AM01FF) which is ordered separately.
- Shelves and dividers are reconfigurable.
- Includes three (3) 10" and six (6) 11" wide adjustable shelves.
- Additional shelves may be ordered separately.

3-Rail divider kit

Item	Components	Dimensions			Shipping Weight
		H	W	D	
UM41	3-Rail divider kit	3.5"	32.36"	15.9"	5 lbs.
U042	Extra rails/compressors (includes 2)				1.5 lbs.

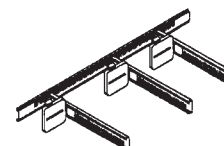

UM41

Drawer mats

Item	Quantity	Shipping Weight
UM80	5	3 lbs.
UM81	10	4 lbs.

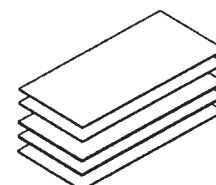

UM80

**Optimedia Storage System
Components and Accessories**

Wire racks

Item	Media Compatibility	Req. Space	Capacity	Maximum Media Size		Shipping Weight
				D	W	
UM40FM	3480/90, 3590 Tapes	5.5"	91	1"	4.37"	5 lbs.
	Microfile	4.5"	91			
	Zip	4.5"	182 (2 per slot)			
	3.5" Optical disk	4.5"	182 (2 per slot)			
UM48FM	8mm Tapes	7" (angled)	102 (2 per slot)	1.75"	4.5"	6 lbs.
	Mini 1/4" data cartridges	4.5" (flat)				
	Audio cassettes Sony AIT, Ditto, Travan					
UM44FM	4mm Tapes	6.5" (angled)	176 264 SHARK (2 per slot)	1.32"	3.63"	5.5 lbs.
	SHARK DAT	4.5" (flat)				
UM46FM	CDs, RW optical disks	5.75"	115	.5"	5.69"	10 lbs.
UM45FM	CDs, RW optical disks	6.25"	180	.87"	5.23"	5.75 lbs.
UM92FM	CDs	6.25"	84	2.03"	5.23"	5 lbs.
UM93FM	CDs	6"	65	.98"	5.69"	5 lbs.
UM51FM	1/4" Data cartridges	5"	60	.94"	6.5"	5 lbs.
UM50FM	Digital linear tapes, TK50/70/85/88/857 .50" Compac tapes	5"	66 (in cases)	1.32"	4.88"	5 lbs.
UM94FM	JAZ Tapes, Magstar MP 3570 tapes	6"	75 (in cases)	.88"	5.44"	5 lbs.
UM57FM	Bernoulli disk	7"	88	1.24"	6.48"	6 lbs.
UM59FM	Syquest cartridge	7.5"	52			6 lbs.

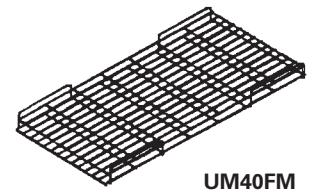
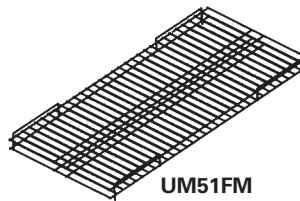
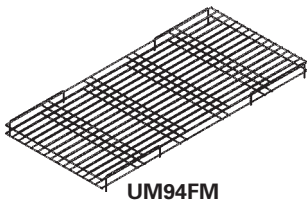

Filing Companions Storage and Filing

Eaton's Filing Companions includes storage and filing options to complement our specialized multimedia cabinets. An extension of our mobile pedestal offering, they provide affordable storage solutions for conventional and personal filing needs.

- Pre-configured for easy ordering
- All models come with a limited lifetime warranty



Wardrobe tower

Item	Description	Dimensions			Details
		H	W	D	
WARD64L2	2-Drawer model	64.1"	23.5"	23.5"	Full-height coat closet on left side with side-to-side coat rod, 37" upper cupboard with two adjustable shelves and two 12" x 19" file drawers.
WARD64L3	3-Drawer model	64.1"	23.5"	23.5"	Full-height coat closet on left side with side-to-side coat rod, 25" upper cupboard with one adjustable shelf with one 12" x 19" file drawers.

Wardrobe Tower additional dimensions:

- Interior closet clearance: 7.5"W
- Interior cupboard clearance: 15"W
- Interior file drawer: 19"D



WARD64L3

Double door storage cabinet

Item	Description	Dimensions			Details
		H	W	D	
DDSC5236	4-High double-door model	52"	36"	17.4"	Features 3 adjustable shelves
DDSC6436	5-High double-door model	64.1"	36"	17.4"	Features 4 adjustable shelves



DDSC6436

Bookcases

Item	Description	Dimensions			Details
		H	W	D	
BC3H4136	3-High bookcase model	41"	36"	13.4"	Features 2 adjustable shelves
BC4H5336	4-High bookcase model	53.4"	36"	13.4"	Features 3 adjustable shelves
BC4H6636	5-High bookcase model	66.4"	36"	13.4"	Features 4 adjustable shelves



BC3H4136

TechCart Mobile Furnishings



TechCart

TechCart Mobile Furnishings

TechCart

- A** Plastic cable raceway cover easily snaps off to provide access to a full vertical raceway.
- B** TechCart components are adjustable on one inch centers. Mounting hardware attaches to plastic grommets for electrical isolation. Adjusting TechCart components is easy and requires no special tools.
- C** Shelves and worksurfaces feature fully radiused comfort edges.
- D** Large, four inch twin wheel casters make it a breeze to move TechCart around. Front casters are locking, suitable for office or production floors.
- E** Cable access ports (3.5" x 1.75") are located from top to bottom on TechCart uprights for a multitude of entry points to the vertical raceway. Power and data can be routed separately.

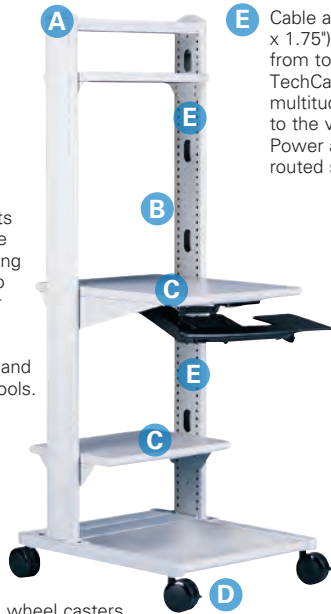

Features & benefits

- “Best-in-class” reputation
- Impressive construction and durability
- Modular reconfigurable design
- Thoughtful ergonomics
- Technology-friendly cable and power management



Laptop cart

Item	Description	Shipping Weight
TCLT1800	Laptop cart, 18 bay capacity with desktop cable port	225 lbs.
TCLT1801	Laptop cart, 18 bay capacity with PowerZone	225 lbs.
TCLT2400	Laptop cart, 24 bay capacity with desktop cable port	255 lbs.
TCLT2401	Laptop cart, 24 bay capacity with PowerZone	255 lbs.



Peripheral cart

Item	Description	Dimensions			Shipping Weight
		H	W	D	
TCPK0001	Peripheral cart	20"	26"	24"	77 lbs.
TCPK0002	Peripheral cart	20"	32"	24"	88 lbs.



TechCart Mobile Furnishings

PC cart

Item	Description	Dimensions			Shipping Weight
		H	W	D	
TCPK0005	PC cart	65"	26"	30"	95 lbs.
	Top shelf worksurface		21.2" 21.2"	12" 30"	
TCPK0006	PC cart	65"	32"	30"	105 lbs.
	Top shelf Worksurface		27.2" 27.2"	12" 30"	



Transporter cart

Item	Description	Dimensions			Shipping Weight
		H	W	D	
TCPK0010	Transporter cart	46"	32"	30"	180 lbs.
	Top shelf		31.2"	30"	
	Bottom shelf Center shelves (qty. 2)		27.2" 27.2"	30" 30"	
TCPK0011	Transporter cart	46"	38"	30"	202 lbs.
	Top shelf		37.2"	30"	
	Bottom shelf Center shelves (qty. 2)		33.2" 33.2"	30" 30"	



Training station

Item	Description	Dimensions			Shipping Weight
		H	W	D	
TCPK0013	Training station cart	29"	32"	30"	81 lbs.
	Top mount worksurface		31.2"	30"	
TCPK0014	Training station cart	29"	38"	30"	87 lbs.
	Top mount worksurface		37.2"	30"	
TCPK0015	Training station cart	29"	48"	30"	102 lbs.
	Top mount worksurface		47.2"	30"	



Stand-up cart

Item	Description	Dimensions			Shipping Weight
		H	W	D	
TCPK0024	Stand-up cart	73"	26"	30"	117 lbs.
	Top shelf		21.2"	12"	
	Worksurface		21.2"	30"	
	Bottom shelf		21.2"	18"	



TechCart

TechCart Mobile Furnishings

Graphics & CAD cart

Item	Description	Dimensions			Shipping Weight
		H	W	D	
TCPK0030	Graphics & CAD cart	29"	38"	30"	101 lbs.
	Top mount worksurface		37.2"	30"	
	Bottom shelf		33.2"	12"	
TCPK0031	Graphics & CAD cart	29"	48"	30"	120 lbs.
	Top mount worksurface		47.2"	30"	
	Lower shelf		43.9"	12"	



Video conference cart

Item	Description	Dimensions			Shipping Weight
		H	W	D	
TCPK0037	Video conference cart	46"	32"	30"	119 lbs.
	Center mount top shelf		31.2"	24"	
	Center mount shelf		27.2"	24"	
	Bottom shelf		27.2"	24"	
TCPK0038	Video conference cart	46"	38"	30"	130 lbs.
	Center mount top shelf		37.2"	24"	
	Center mount shelf		33.2"	24"	
	Bottom shelf		33.2"	12"	



Storage cart

Item	Description	Dimensions			Shipping Weight
		H	W	D	
TCPK0040	Storage cart frame with casters	73"	32"	30"	135 lbs.
	Locking compartment with fabric covered door	16"	26.5"	15"	
	Center mounted shelves		21.2"	18"	
	(qty. 2)				



Presentation cart

Item	Description	Dimensions			Shipping Weight
		H	W	D	
TCPK0041	Presentation cart	65"	32"	30"	152 lbs.
	Center mounted shelves (qty. 3)		27.2"	30"	
TCPK0042	Presentation cart	65"	38"	30"	157 lbs.
	Center mounted shelves (qty. 3)		31.2"	30"	



TechCart Mobile Furnishings

Network cart

Item	Description	Dimensions			Shipping Weight
		H	W	D	
TCPK0057	Network cart	65"	26"	30"	120 lbs.
	Center mount shelf		21.2"	24"	
	Center mount shelf and bottom shelf		21.2"	30"	
TCPK0058	Network cart	65"	32"	30"	143 lbs.
	Center mount shelf		27.2"	24"	
	Center mount shelf and bottom shelf		27.2"	30"	



Analytical cart

Item	Description	Dimensions			Shipping Weight
		H	W	D	
TCPK0061	Analytical cart	46"	26"	30"	107 lbs.
	Top mount worksurface		25.2"	30"	
	Shelf		21.2"	18"	
	Storage shelf		21.2"	12"	



Design cart

Item	Description	Dimensions			Shipping Weight
		H	W	D	
TCPK0200	Design cart	42"	48"	36"	130 lbs.
	15° Forward tilt-adjustable center mount top shelf		48"	36"	
	Center mount shelf		43.9"	12"	



TechCart

Paramount Enclosure System

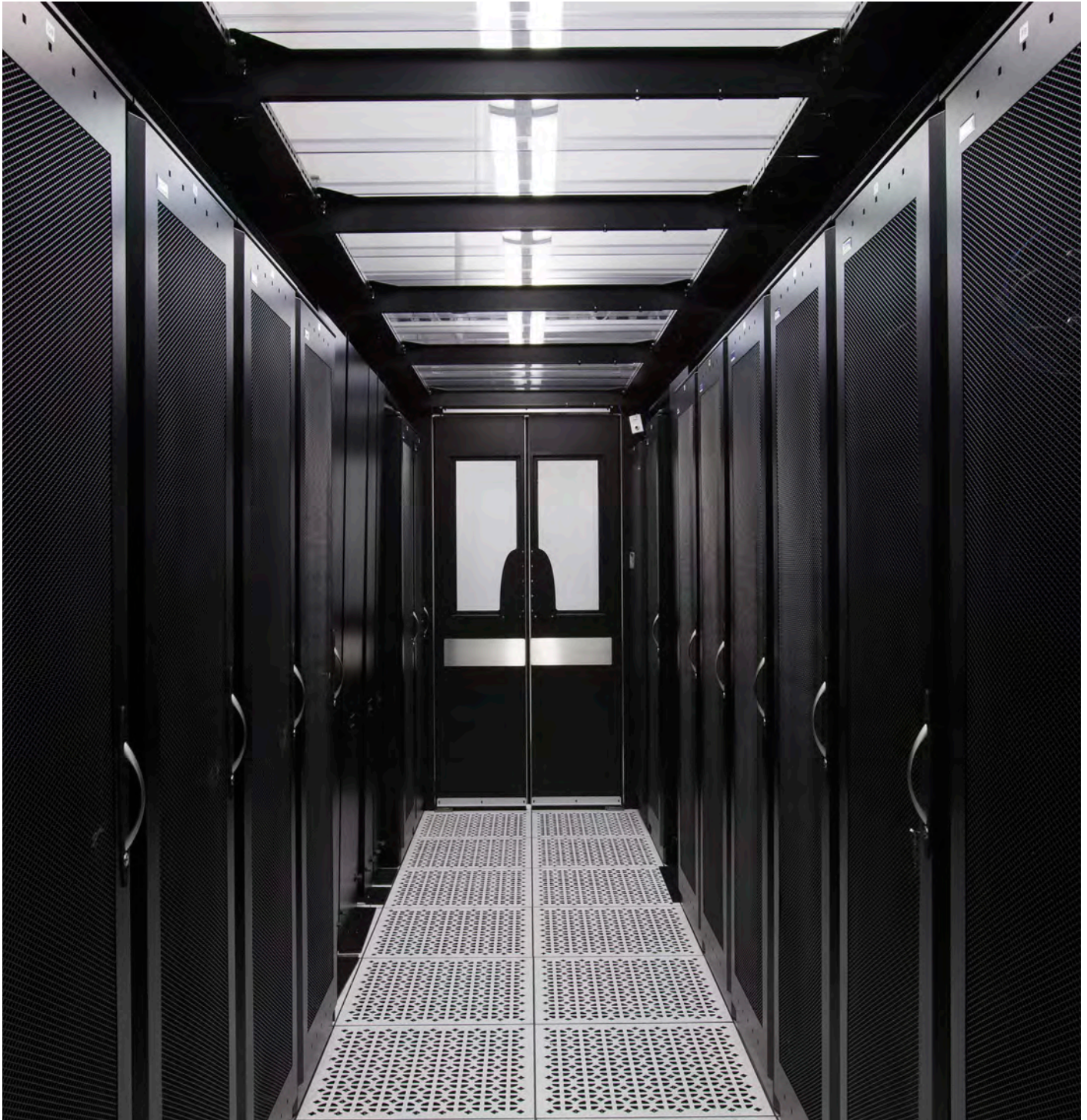

Paramount

Paramount Enclosure System

Paramount™ enclosures, with its accompanying integrated technologies, provides unmatched reliability to better store, cool, power, manage and secure your mission-critical electronics and servers.



Features & benefits

- Unique design allows for easy reconfiguration for changing needs
- Available in a variety of heights, depths and widths
- Full line of accessories to meet the specific storage requirements of virtually all network equipment.

Paramount enclosures

Item	Description	Shipping Weight
Configured	Paramount 24" wide enclosure	322.4 lbs.
JW842440	84"H x 24"W x 40"D Welded Paramount frame	109 lbs.
JFTK24	24"W Paramount frame trim kit	7 lbs.
JSPS8440	44U x 40"D Solid side panel (qty. 2)	84 lbs.
JDF8424L	84"H x 24"W Door frame - left hinged	21 lbs.
JDP84242	84"H x 24"W Fully perforated door with standard lock	7 lbs.
WL100	Removable lock core with 2 keys (qty. 2)	.4 lbs.
JDD8421	84"H x 24"W Split rear door, perforated	33 lbs.
JTPS2440	24"W x 40"D Solid top panel	12 lbs.
JRM10000	44U Paramount rail - 19" EIA - .375" square hole (includes 4)	49 lbs.

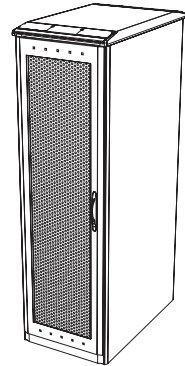

Item	Description	Shipping Weight
Configured	Paramount add-on enclosure	238.4 lbs.
JW842440	84"H x 24"W x 40"D Welded Paramount frame	109 lbs.
JFTK24	24"W Paramount frame trim kit	7 lbs.
JDF8424L	84"H x 24"W Door frame - left hinged	21 lbs.
JDP84242	84"H x 24"W Fully perforated door with standard lock	7 lbs.
WL100	Removable lock core with 2 keys (qty. 2)	.4 lbs.
JDD8421	84"H x 24"W Split rear door, perforated	33 lbs.
JTPS2440	24"W x 40"D Solid top panel	12 lbs.
JRM10000	44U Paramount rail - 19" EIA - .375" square hole (includes 4)	49 lbs.

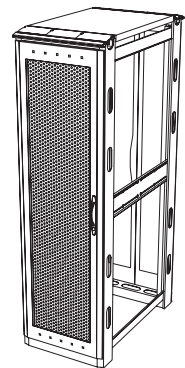

Item	Description	Shipping Weight
Configured	Paramount 30" wide enclosure	398.4 lbs.
JW843040	84"H x 30"W x 40"D Welded Paramount frame	115 lbs.
JFTK30	30"W Paramount frame trim kit	9 lbs.
JSPS8440	44U x 40D Solid side panel (qty. 2)	84 lbs.
JDF8430L	84"H x 30"W Door frame - left hinged	22 lbs.
JDP84302	84"H x 30"W Fully perforated door with standard lock	9 lbs.
WL100	Removable lock core with 2 keys (qty. 2)	.4 lbs.
JDD8431	84"H x 30"W Split rear door, perforated	35 lbs.
JTP10005	30"W x 40"D, High density solid top panel, OHCM	14 lbs.
JRM10039	44U Reducer rail - 19" EIA - .375" square hole (includes 4)	110 lbs.

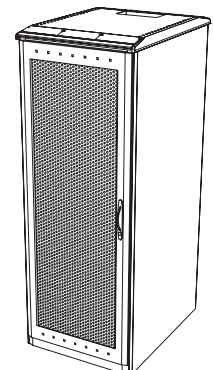

Paramount

Seating



Seating

Eaton’s ergonomic seating portfolio includes something for every work environment. From 24/7 continuous shift and big and tall accommodations to executive office and task-intensive selections, we have a wide range of options for office, technical, lobby, and meeting room chairs.

- **24/7 Seating** designed to withstand constant use in around-the-clock environments.
- **General office seating** options for private workstations and guest seating, conference rooms and training environments.
- **Lab/industrial seating** provides the ergonomic support necessary for optimum comfort and productivity.



General Office



Task

Guest

Conference

Colors & Finishes

Laminate options for furniture

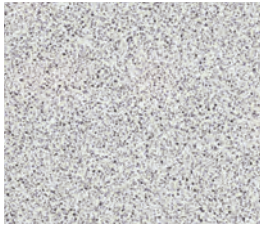

White Matrix (K)



Charcoal Matrix (G)



Buka Bark (C)



Lodestone (H)



Silver (V)

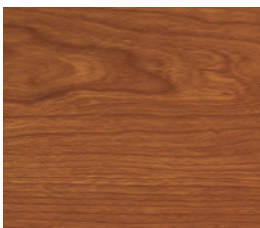

American Cherry (A)



Maple (Y)



Astro Strandz (Z)

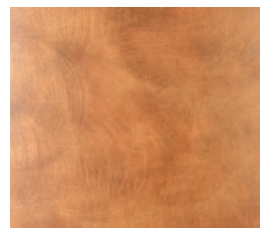

Antique Brush (Q)

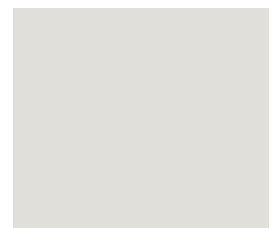

ESD Grey (E)



Beigewood (W)

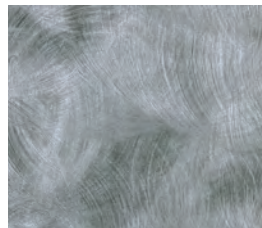

Pewter Brush (P)

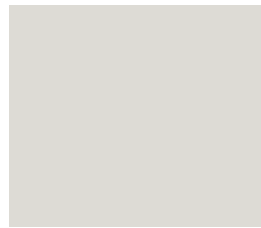

Folkstone Grey (L)

Steel options for furniture

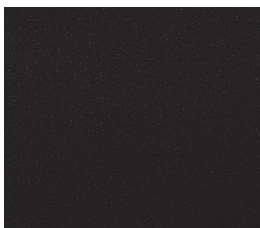

Black (M)

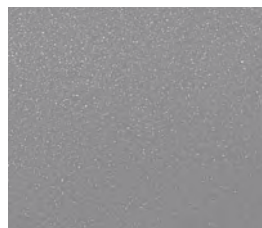

Titanium (V)



Metal Grey (H)

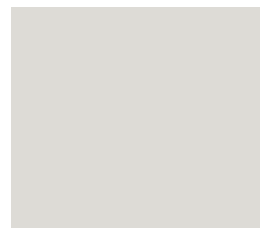

Nugrey (F)



Warm Brown II (R)

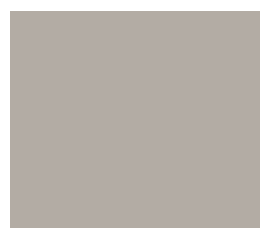

Bronze Taupe (D)

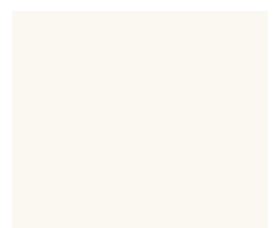

Cream White (C)

Colors & Finishes

Furniture matrix**

Laminate	Compass™	LINX™	Optimedia™ (Sidewinder)	Optimedia (Classic)	Profile™	Foundations / LMS	TechCart	TechBench	Filing Companions	TechOrganizer
White Matrix (K)	•	•	•	•	•	•	•	•		
Charcoal Matrix (G)	•	•	•	•	•	•	•	•		
Buka Bark (C)	•	•	•	•	•	•	•	•		
Lodestone (H)	•	•	•	•	•	•	•	•		
Silver (V)	•	•	•	•	•	•	•	•		
American Cherry (A)	•	•	•	•	•	•	•	•		
Maple (Y)	•	•	•	•	•	•	•	•		
Astro Strandz (Z)	•	•	•	•	•	•	•	•		
Antique Brush (Q)	•	•	•	•	•	•	•	•		
ESD Grey (E)	•	•	•	•	•	•	•	•		
Beigewood (W)	•	•	•	•	•	•	•	•		
Pewter Brush (P)	•	•	•	•	•	•	•	•		
Folkstone Grey (L)	•	•	•	•	•	•	•	•		
Steel	Compass	LINX	Optimedia (Sidewinder)	Optimedia (Classic)	Profile	Foundations / LMS	TechCart	TechBench	Filing Companions	TechOrganizer
Black (M)	•	•	•	•	•	•	•	•	•	•
Titanium (V)	•				•	•*	•*	•		•*
Metal Grey (H)	•	•	•	•	•	•*	•*	•	•	•*
Nugrey (F)	•	•	•	•	•	•	•	•	•	•
Warm Brown II	•	•	•	•					•	•*
Bronze Taupe (D)					•*					
Cream White (C)	•	•	•	•	•	•	•	•	•	•
Wood	Compass	LINX	Optimedia (Sidewinder)	Optimedia (Classic)	Profile	Foundations / LMS	TechCart	TechBench	Filing Companions	TechOrganizer
Maple Hardwood								•		

*Coordinating plastics available in Black only.

**For Eaton's OnGuard command console color options, see the OnGuard Color Collections below and on next page.

Laminate trim matrix (Rounded bullnose edgebanding)

Laminate	Trim
White Matrix (K)	NuGrey
Charcoal Matrix (G)	Black
Buka Bark (C)	Warm Brown
Lodestone (H)	Metal Grey
Silver (V)	Black
American Cherry (A)	Black
Maple (Y)	Black
Astro Strandz (Z)	Metal Grey
Antique Brush (Q)	Black
ESD Grey (E)	NuGrey
Beigewood (W)	Metal Grey
Pewter Brush (P)	Metal Grey
Folkstone Grey (L)	NuGrey

Compass laminate trim matrix (Flat edgebanding)

Laminate	Trim
White Matrix (K)	NuGrey
Charcoal Matrix (G)	Black
Buka Bark (C)	Warm Brown
Lodestone (H)	Metal Grey
Silver (V)	Black
American Cherry (A)	American Cherry
Maple (Y)	Maple
Astro Strandz (Z)	Metal Grey
Antique Brush (Q)	Black
ESD Grey (E)	NuGrey
Beigewood (W)	Metal Grey
Pewter Brush (P)	Metal Grey
Folkstone Grey (L)	NuGrey

Paramount enclosure matrix

Steel Panels
NuGrey
Black
Steel Doors
Titanium
NuGrey
Black

OnGuard trim matrix

Name	Laminate	Steel	Edge Trim	Laminate Color	Steel Color	Edge Trim Color
Freedom	Buka Bark (C)	Bronze Taupe	Brown			
Heritage	American Cherry (A)	Black	Black			
Justice	Astro Strandz (Z)	Metal Grey	Grey			
Liberty	Antique Brush (Q)	Black	Black			
Patriot	Beigewood (W)	Titanium	Grey			
Revolution	Pewter Brush (P)	Titanium	Grey			

Note: Paramount enclosures (NuGrey or Black) come with black rails with white RU markings. Steel doors can be specified in additional colors if ordering a "configured to order" enclosure.

Colors and finishes

GSA Product Catalog

Options

OnGuard console color collections

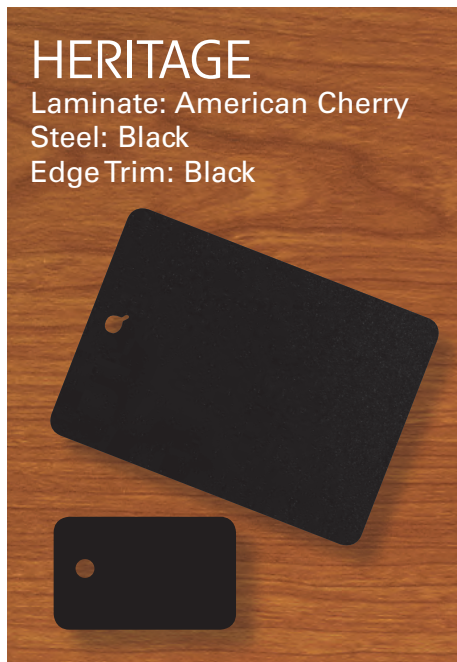

To contact an Eaton salesperson or local distributor, please visit eaton.com/furniture or call 800-225-7348.

Eaton
1000 Eaton Boulevard
Cleveland, OH 44122
United States
Eaton.com

© 2018 Eaton
All Rights Reserved
Printed in USA
Publication No. CA210001EN
May 2018 GSA-18

Eaton is a registered trademark.
All other trademarks are property of their respective owners.

